

INSTALLATION GUIDE

INTRODUCTION

The EI series of Industrial Ethernet hubs allow for the expansion of shared 10 Mbps Ethernet networks on the plant floor. A hub is necessary to expand a 10BASE-T system beyond two nodes or to increase network distances beyond the 100-meter limit of the 10BASE-T specification. Two EI models offer expansion via twisted-pair cabling—the four-port EI4-10T and the eight-port EI8-10T. When greater distance or galvanic isolation is required, a fiber link can be implemented with model EI6-10T/F which has two fiber ports and four ports for twisted-pair.

EI hubs feature wide-range low-voltage AC or DC power requirements and provisions for redundant power connections. All EI models support the signaling requirements of 10BASE-T while conforming to the requirements for IEEE 802.3 repeater units. These requirements include preamble regeneration, symmetry and amplitude compensation. A repeater must retiming signals so that jitter, introduced by transceivers and cabling, does not accumulate over multiple segments. It must be able to detect either runt packets or collisions and reinforce that detection by generating a Jam signal. Finally, it needs to automatically partition jabbering ports so that the complete network is not rendered useless.

Each EI hub provides digital pre-emphasis to its transmitting ports to compensate for the inherent signal strength roll-off of twisted-pair cable. Each twisted-pair segment can be up to 100 meters in length. Shielded RJ-45 connectors accommodate either UTP or STP cabling. Fiber segment length can be as great as 2 km. Link Integrity is monitored, confirming a working adapter or hub is on the other end of the segment. Hubs can be cascaded using a crossover cable.

There are several LED indicators supplied that aid trouble-shooting. Besides one common Collision LED, each port has a pair of LEDs to indicate link status and port activity. Their definitions are compatible with the company's IEISA and IE104 series of Ethernet network interface modules.

The EI series is intended for Industrial Ethernet applications and complies with the EMC compatibility standards for immunity and emissions in an industrial environment. Units can be either panel or DIN-rail mounted.

SPECIFICATIONS

Electrical

INPUT	DC	AC
Voltage:	10–36 volts	8–24 volts
Power:	5 W	5 VA
Frequency:	N/A	47–63 Hz

Environmental

Operating Temperature:	0°C to +60°C
Storage Temperature:	–40°C to +85°C

Regulatory Compliance

CE Mark, UL 508 Listed,
CFR 47 Part 15 Class A
C-UL Listed, CSA Std. C22.2 No. 14-M91

Functional

Compliance:	ANSI/IEEE 802.3
Data Rate:	10 Mbps
Signaling:	10BASE-T and 10BASE-FL

LED Indicators:

ENTIRE HUB	EACH PORT
Collision—red	Link—green Activity—yellow

Shipping Weight

2 lbs. (.9 kg)

Cabling

Signaling:	10BASE-T	10BASE-FL
Port Connectors:	Shielded RJ-45	Type ST
Segment Length:	100 m maximum	2 km maximum ¹

¹ This maximum only applies if the segment contains purely 10BASE-FL equipment.
When 10BASE-FL is mixed with other types of devices, maximum fiber length is less.

10BASE-T MDI-X CONNECTOR PIN ASSIGNMENTS²

RJ-45	Usage
1	TD+
2	TD–
3	RD+
4	Not Used
5	Not Used
6	RD–
7	Not Used
8	Not Used

² The MDI-X interface implements the internal crossover function so that network interface adapters attach to hubs with straight-through cables, but hubs connect to each other with crossover cables.

Mechanical

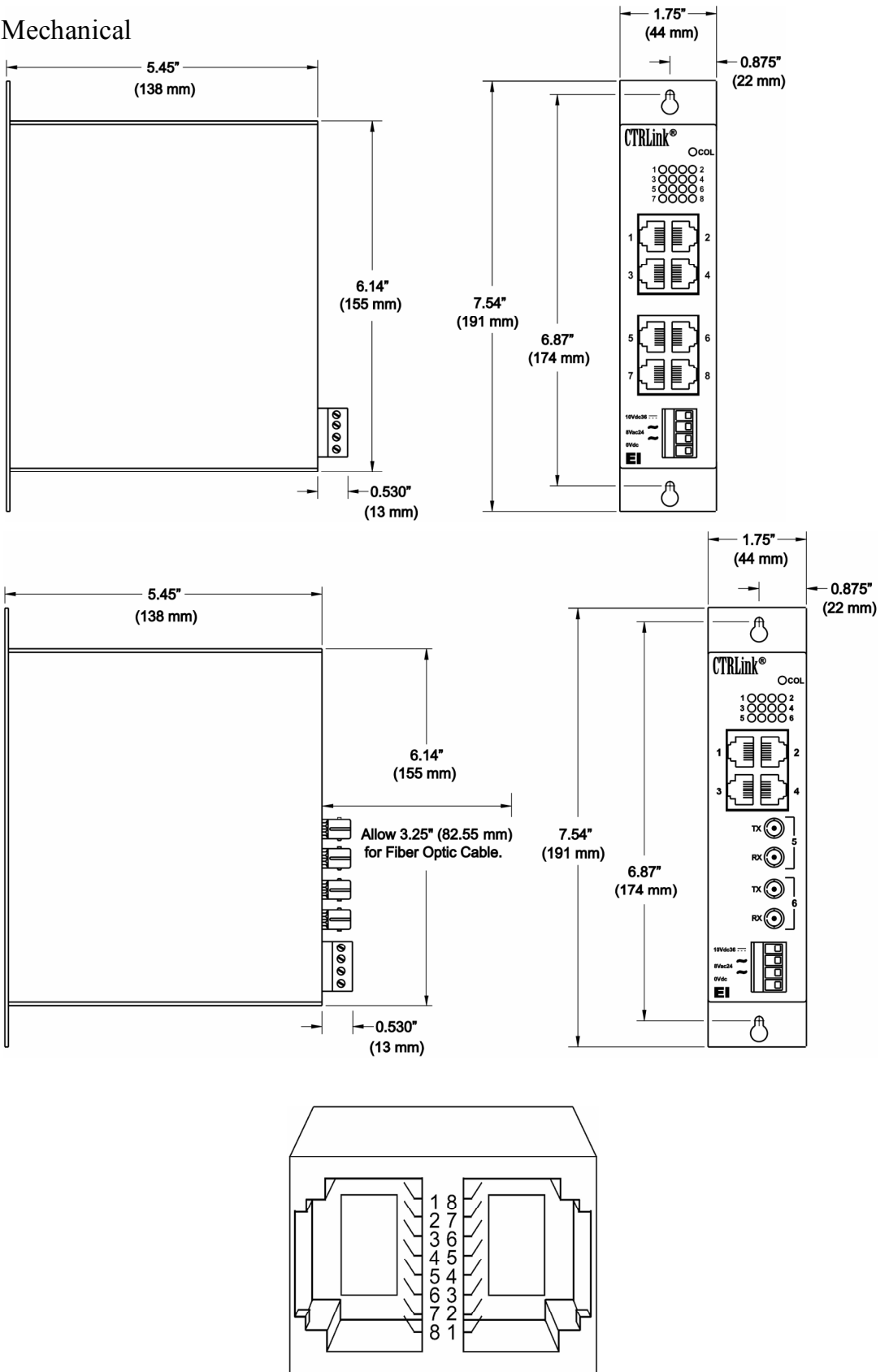

Figure 1 — Connector Pin Assignments

INSTALLATION

The EI is intended for mounting onto a vertical panel within an industrial control enclosure. Two #8 screws can be used for mounting the EI in a vertical orientation. Refer to the mechanical specifications for details.

If it is desirable to mount the EI onto a DIN rail, an optional DIN rail mounting clip (AI-DIN) must be purchased and installed on the rear of the EI. Once the clip is mounted to the EI, the EI can be snapped onto the DIN rail.

The EI requires either low voltage AC or DC power in order to operate. Consult the specifications for power requirements. Power is provided to a four pin removable keyed connector and there are several methods for providing power.

DC Powered

The EI accepts a voltage range of 10–36 VDC and draws a current value commensurate with 5-watt power consumption. Power conductors should be sized accordingly. Ground is directly connected to zero volts and the equipment chassis is isolated from zero volts. The input connections are reverse-polarity protected.

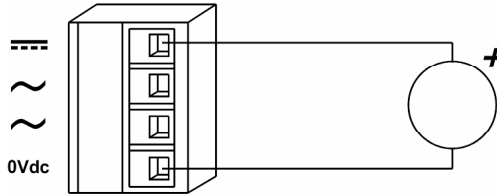

Figure 2 — DC Powered

Redundant DC Powered

Redundant diode-isolated DC power inputs are provided so the EI can operate despite the loss of primary power. Both sources must provide 5 watts of power. Do not assume that input currents will be balanced from the two supplies.

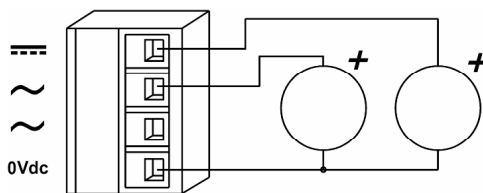

Figure 3 — Redundant DC Powered

AC Powered

The EI can be powered by an AC voltage in the range of 8–24 V capable of delivering 5 VA of apparent power. Two auxiliary power supplies are available: The AI-XFMR is for use with 120 VAC. The AI-XFMR-E is for use with 240 VAC.

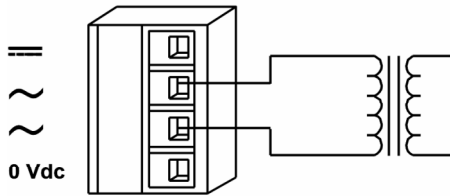

Figure 4 — AC Powered

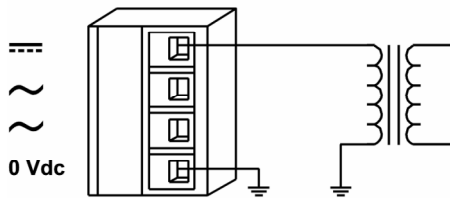

Figure 5 — AC Powered with Grounded Secondary

AC Powered with Battery Backup

The EI can also operate in the AC mode with a backup battery providing power, if the AC source fails. The EI does NOT charge the battery, so separate provisions are required for charging.

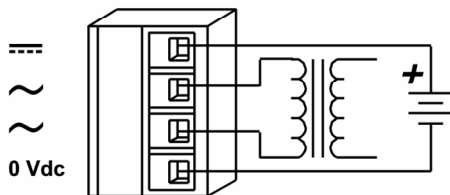

Figure 6 — AC Powered with Battery Backup

Front Panel LEDs

The EI series incorporates green and yellow LED indicators for each port. The green LED indicates a link is established between the EI hub and the DTE (data terminal equipment) or another hub. The green LED will turn on and remain illuminated as soon as a cable from a powered Ethernet NIM (network interface module) is connected to the EI. The yellow LED indicates receive activity and will flash or remain illuminated in accordance with the amount of data being received. In addition, a single red LED is used to indicate a collision is occurring on the network. It is considered normal to have some collisions on the network.

Implementing Multi-Segment Networks with EI Hubs

Note: The following discussion is limited to 10BASE-T and 10BASE-FL devices. For a consideration of other signaling equipment, refer to IEEE 802.3.

For two devices to communicate over an Ethernet network, the transmitter of one device must be connected to the receiver of the other device. EI units have “normal” ports with MDI-X wiring which implements the crossover function internally. Computer and workstation NIMs have “uplink” ports that are MDI wired and connect to normal ports via standard straight-through cables. Normal ports connect to each other with crossover cables. Therefore, EI units attach to each other via crossover cabling—regardless of topology—and whether using fiber or twisted-pair cables. EI ports accept RJ-45 connectors for twisted-pair (shielded or unshielded) and ST connectors for fiber.

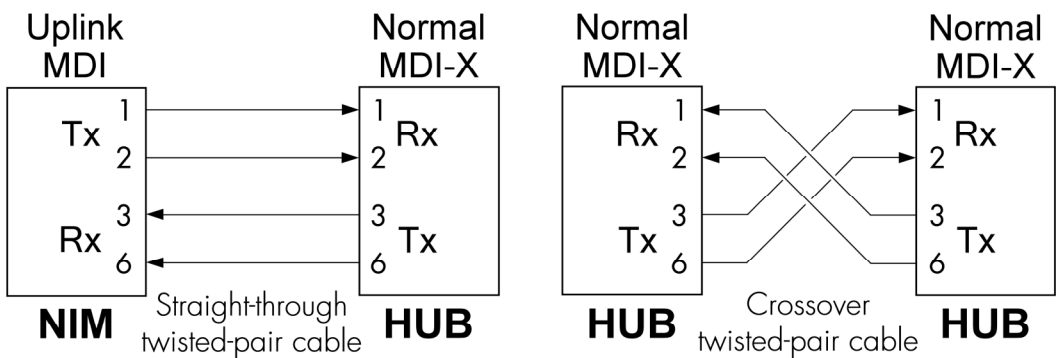

Figure 7 — Uplink Ports and Normal Ports

In general, a network can have as many as five segments and *no more than four hubs* along any data path. The collision domain must not be exceeded. The limiting factor is the *round-trip* time (57.5 μ s at 10 Mbps) for a signal propagating between the two furthest nodes. As a signal passes through an EI hub, it experiences a delay which is compliant with IEEE 803.2, Section 9.5.5.1. The various other contributors of delay (cables, transceivers, etc.) are covered by IEEE 802.3.

A common network design decision is whether to optimize the number of nodes or the network diameter. The maximum number of nodes (62) is achieved with twisted-pair media and uses ten EI8-10T units configured in a distributed-star topology (Figure 10). The maximum network diameter (2200 m) is attainable using fiber links where no data path has more than four fiber hubs—regardless of topology—and twisted-pair is used to connect each end device.

If only twisted-pair media is used in a five-segment network, each segment is limited to 100 m and so the maximum network diameter is 500 m. This limit applies to either topology, cascaded or distributed-star. However, the distributed-star maximizes the number of devices that can be networked.

To optimize distance, the typical network would use twisted-pair wiring for the end devices and fiber cables for the inter-hub links. Each twisted-pair can be as long as 100 m and the total length of fiber can be as much as 2000 m. The network diameter cannot exceed 2200 m, but the length of each fiber link depends on the number of segments used. If a data path contains just one pair of EI units, the fiber link between them can be as great as 2000 m. If the path has three EI units, each fiber link is limited to 1000 m. If the path has the maximum of four EI units, each fiber link is limited to 500 m. In all cases, the network diameter limit is 2200 m.

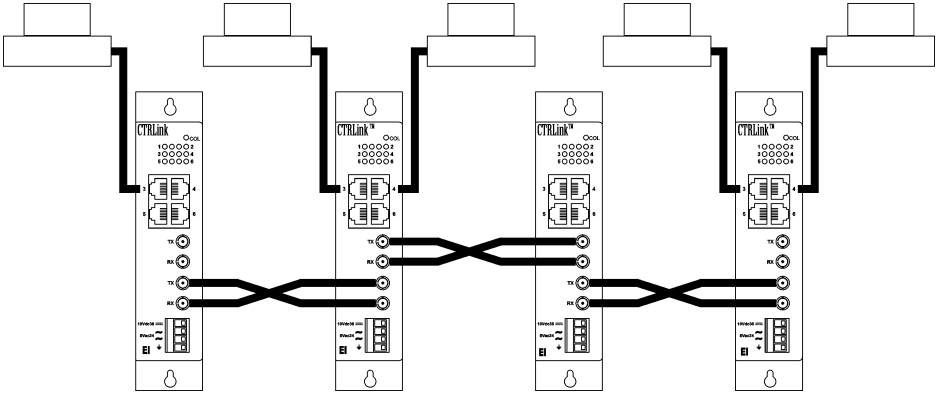

Figure 8 — Cascading with Duplex Fiber Cables

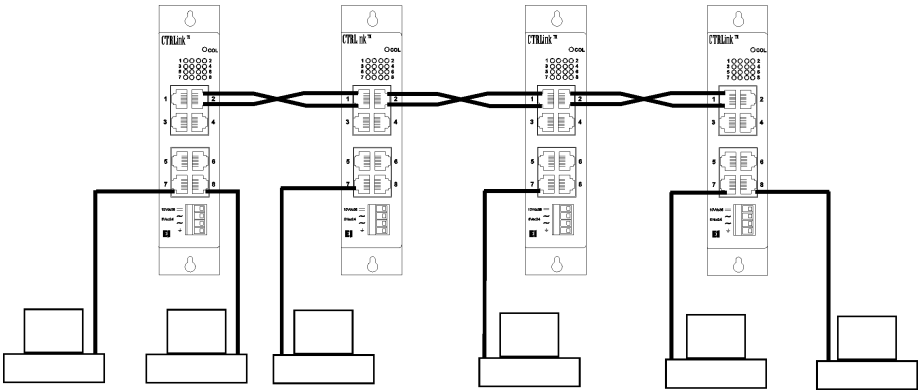

Figure 9 — Cascading with Twisted-Pair Crossover Cables

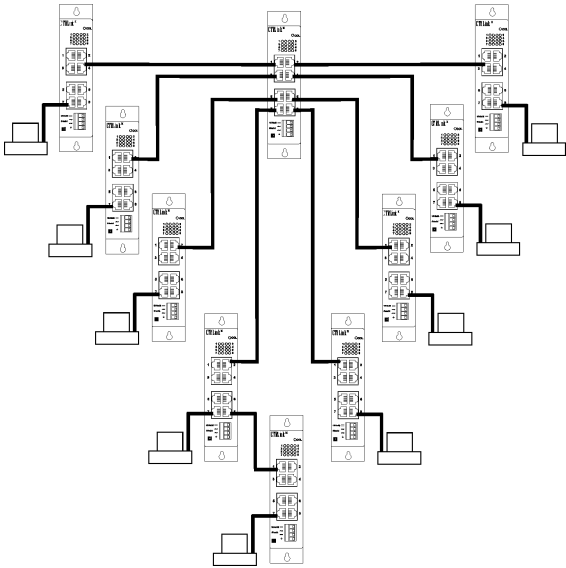

Figure 10 — Distributed-Star Topology

NEED MORE HELP INSTALLING THIS PRODUCT?

More comprehensive information can be found on our web site at www.ccontrols.com. Browse the Technical Support section of our site for a look at our interactive on-line technical manuals, downloadable software drivers and utility programs that can test the product. When contacting one of our offices, just ask for Technical Support.

WARRANTY

Contemporary Controls (CC) warrants its product to the original purchaser for one year from the product's shipping date. If a CC product fails to operate in compliance with its specification during this period, CC will, at its option, repair or replace the product at no charge. The customer is, however, responsible for shipping the product; CC assumes no responsibility for the product until it is received. This warranty does not cover repair of products that have been damaged by abuse, accident, disaster, misuse, or incorrect installation.

CC's limited warranty covers products only as delivered. User modification may void the warranty if the modification damages the product, in which case this warranty does not cover repair or replacement.

This warranty in no way warrants suitability of the product for any specific application.

More warranty information can be found at www.ccontrols.com.

RETURNING PRODUCTS FOR REPAIR

Before returning a product for repair, contact Customer Service. A representative will instruct you on our return procedure.

Contemporary Control Systems, Inc.
2431 Curtiss Street
Downers Grove, Illinois 60515 USA
Tel: +1-630-963-7070
Fax: +1-630-963-0109
E-mail: info@ccontrols.com
WWW: <http://www.ccontrols.com>

Contemporary Controls Ltd
Sovereign Court Two
University of Warwick Science Park
Sir William Lyons Road
Coventry CV4 7EZ UK
Tel: +44 (0)24 7641 3786
Fax: +44 (0)24 7641 3923
E-mail: info@ccontrols.co.uk

DECLARATION OF CONFORMITY

Applied Council Directives:

Electromagnetic Compatibility Directive, 89/336/EEC Council Directive as amended by Council Directive 92/31/EEC & Council Directive 93/68/EEC
General Product Safety Directive 92/59/EEC

Standards to which Conformity is Declared

EN 55022:1995 CISPR22: 1993, Class A, Limits and Methods of Measurement of Radio Disturbance Characteristics of Information Technology Equipment

EN 50082-2:1995, Electromagnetic Compatibility — Generic Immunity Standard, Part 2: Industrial Environment

Manufacturer:

Contemporary Control Systems, Inc.
2431 Curtiss Street
Downers Grove, IL 60515 USA

Authorized Representative:

Contemporary Controls Ltd
Sovereign Court Two
University of Warwick Science Park
Sir William Lyons Road
Coventry CV4 7EZ
UNITED KINGDOM

Type of Equipment: Industrial Ethernet hub

Model	Applied Directive
EI4-10T	EMC
EI5-10T/F	EMC
EI6-10T/F	EMC
EI8-10T	EMC

Manufacturer's Declaration of October 1, 2004: I declare that the above models conform to the above directives and standards.

George M. Thomas, President